

A-A (1:2)

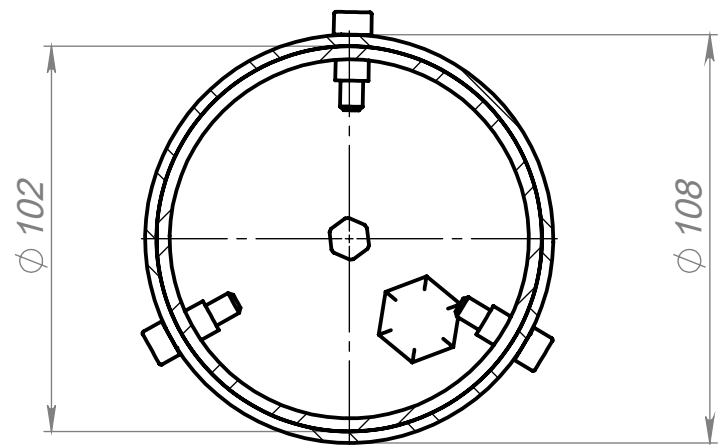

C (1:5)

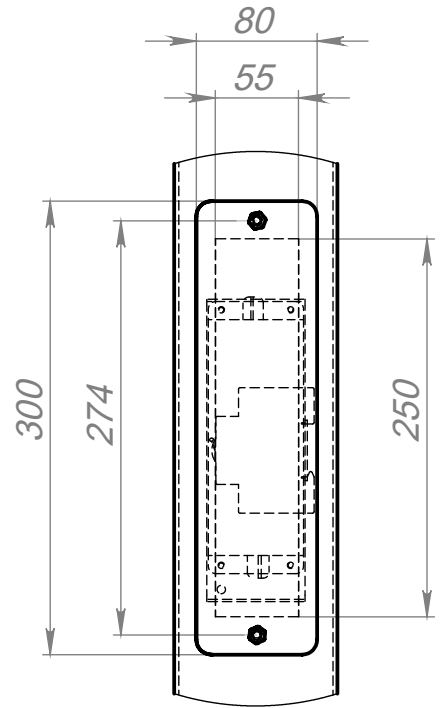

E-E (1:10)

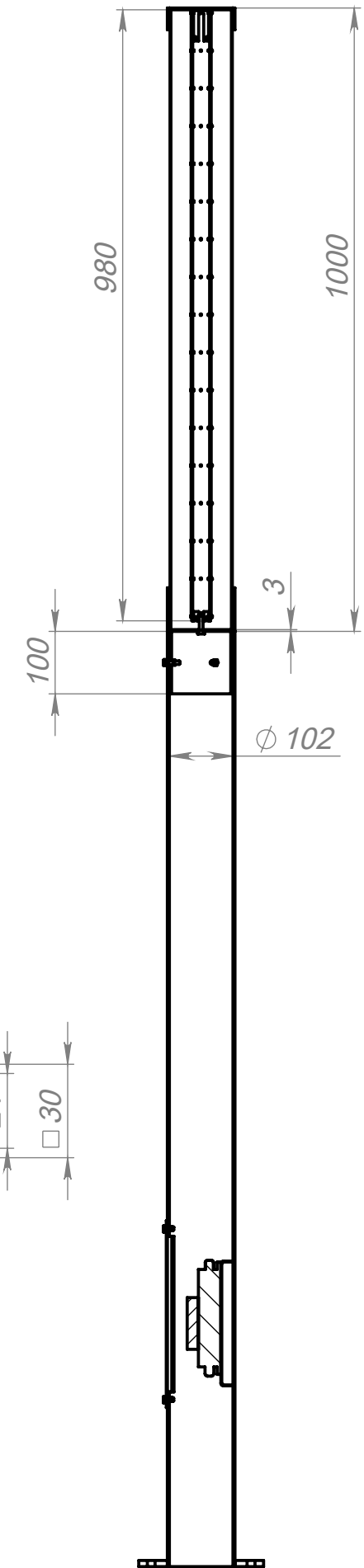

B (1:2)

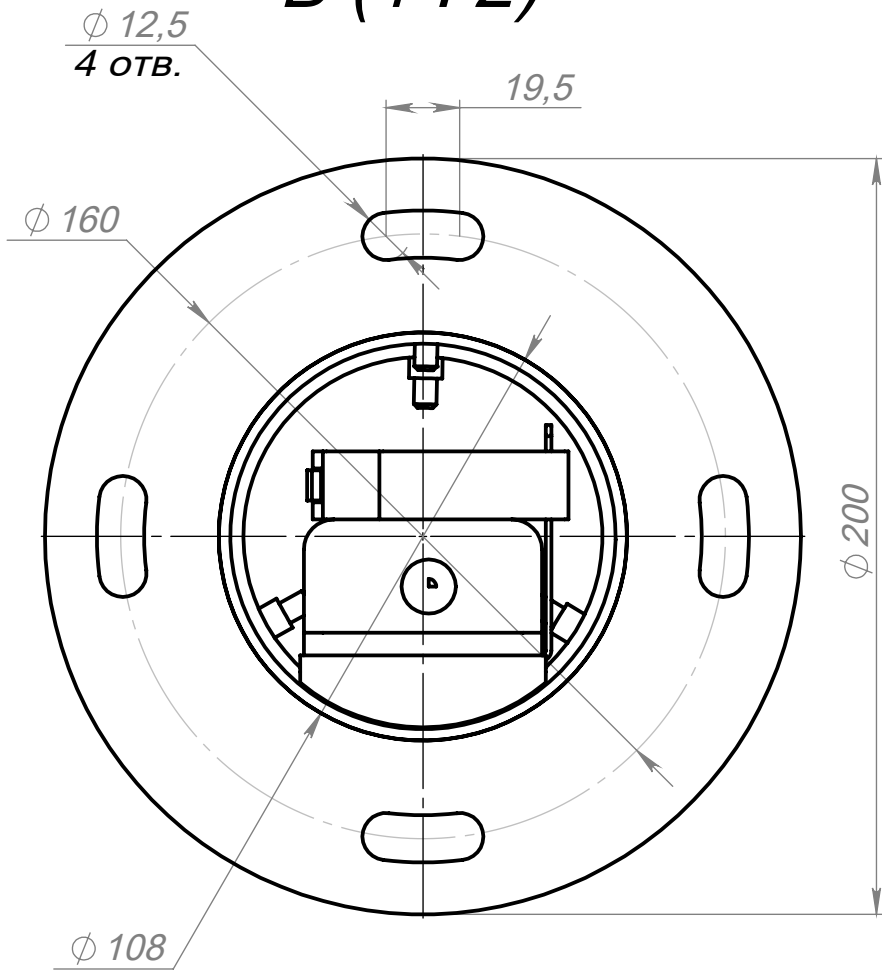

D-D (1:2)

